

Features

- 24VDC units have field selectable candela options of 15, 30, 60, 75 & 110
- Super-Slide® Bracket - Ease of Supervision Testing
- Checkmate® - Instant Voltage Verification
- Synchronize strobe and/or horn with AVSM Control Module
- Prewire entire system, install mounting bracket, then install signals
- Documented lower installation and operating costs
- Switch selection for high or low dBA
- Switch for chime, whoop, mechanical and 2400Hz tone
- Tamperproof re-entrant style grill
- Switch for continuous or temporal 3 tone (not available on whoop tone)
- Silence audible while visual appliance will remain flashing (for use in accepted jurisdictions)
- Faceplate available in red or off-white



Description

The S-24/HS-24 Series is a low profile strobe and horn/strobe combination that offers dependable audible and visual alarms and the absolute lowest current available. The S-24 & HS-24 Series 24VDC offers tamperproof field selectable candela options of 15, 30, 60, 75, and 110 candela. The Strobe and Horn/Strobe offers a continuous or sync temporal three in 2400Hz and mechanical tone, a chime and whoop tone. All tones are easy for the professional to change in the field by the use of switches. The S-24 & HS-24 Series has a minimal operating current and has a minimum flash rate of 1Hz regardless of input voltage.

This Series is shipped with a standard 4” metal mounting plate which incorporates the popular Super-Slide® feature that allows the installer to easily test for supervision. The product also features a locking mechanism which secures the product to the bracket without any screws showing.

The S-24/HS-24 also features the patented Checkmate® - Instant Voltage Verification feature which allows the installer to check the voltage drop draw and match it to the blueprint.

The S-24 & HS-24 Series appliances are ANSI/UL 464 and ANSI/UL 1971, listed for use with fire protective systems and are warranted for three years from date of purchase.

Technical Specifications

Mounting Options	Single or Double gang, 4” square box, and AVBB surface mount back box
Terminals	Screw-Clamp Type
Wire Gauge	18 – 12 AWG
Operating Temp	32°F – 120°F (0° – 49°C)
Dimensions	Height – 5” Width – 4.5” Depth – 2.5”
Shipping Weight	1.05 lbs

TONE	SWITCH POSITION		
	3	4	5
Mechanical Temporal 3	ON	ON	ON
Mechanical Continuous	OFF	ON	ON
2400 Hz Temporal 3	ON	OFF	ON
2400 Hz Continuous	OFF	OFF	ON
Chime Temporal 3	ON	ON	OFF
Chime Continuous	OFF	ON	OFF
Whoop	ON	OFF	OFF
Whoop	OFF	OFF	OFF

NOTE:

- Switch Positions 1 The and 2 in the OFF position to select isolated horn and strobe power inputs
- Switch Position 6 ON = HIGH dBA
- Switch Position 6 OFF = LOW dBA

Candela Selection

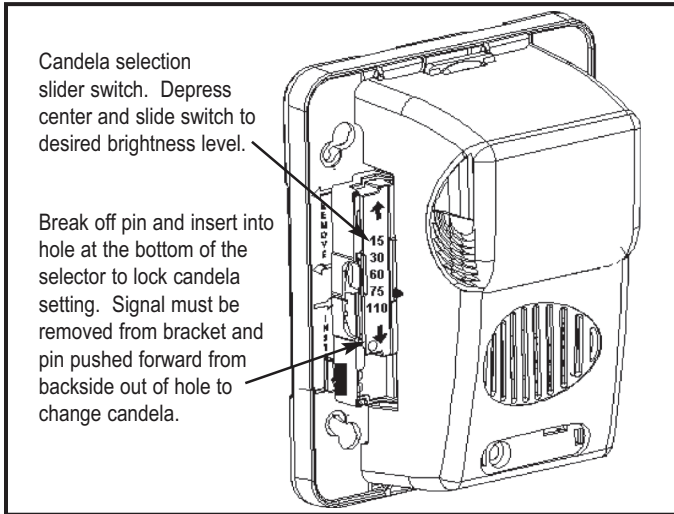

Super Slide® Mounting Bracket
Allows the installer to pre-wire the system, test for system supervision, remove the signal head until occupancy, switch out signals without changing mounting brackets and has locking edge connector for snap-in-place installation.

Switch Locations

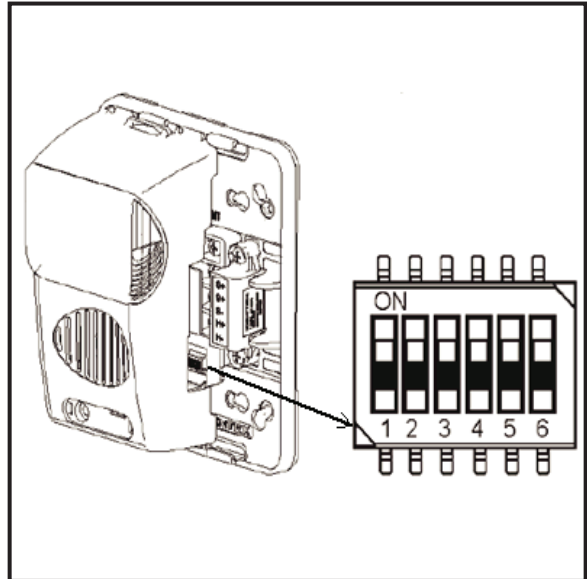

Checkmate™ - Instant Voltage Verification

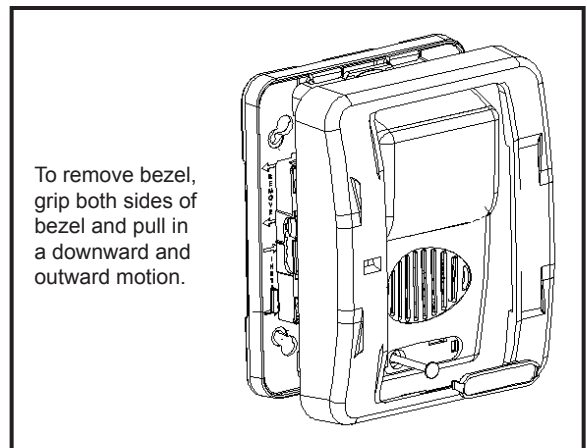
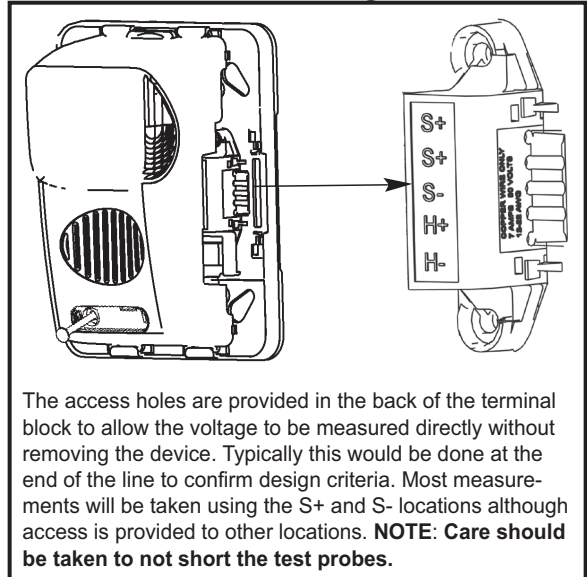

S-24 24 VDC Selectable Candela, Low Profile Evacuation Strobe

Model Number	Part Number	Nominal Voltage	Candela (ANSI/UL 1971)
S-24WR	4890010	24 VDC	15, 30, 60, 75, 110
S-24WW	4890011	24 VDC	15, 30, 60, 75, 110

HS-24 24 VDC Selectable Candela, Low Profile Evacuation Strobe

Model Number	Part Number	Nominal Voltage	Candela (ANSI/UL 1971)	Reverberant dBA at 10 ft, per ANSI/UL 464	In Anechoic Room at 10 ft
HS-24WR	4890030	24 VDC	15, 30, 60, 75, 110	62-82	100
HS-24WW	4890031	24 VDC	15, 30, 60, 75, 110	62-82	100

S-24 & HS 24 Strobe Current Ratings

24 VDC (16 - 33 Volts)		
Candela	24 VDC	UL Max
15 cd	30 mA	42 mA
30 cd	35 mA	58 mA
60 cd	66 mA	97 mA
75 cd	80 mA	116 mA
110 cd	103 mA	161 mA

Model Designations:

W = Wall mount
R = Red Faceplate W=White Faceplate

All units are available in plain (no lettering)
Plain units are non-returnable.

“ALERT” bezel available for order.

“AGENT” bezel available for order.

S-24 & HS-24 Horn Ratings

Horn Mode	Horn Decibel Levels		Horn Current Ratings
	Minimum SPL at 10 ft, per ANSI/UL 464 (HIGH)	Minimum SPL at 10 ft, per ANSI/UL 464 (LOW)	Regulated 24 VDC Max Operating @ High Setting (mA)
Temp 3 (2400 Hz)	78 dBA	71* dBA	28 mA
Temp 3 (Mechanical)	76 dBA	70* dBA	25 mA
Temp 3 (Chime)	70* dBA	66* dBA	15 mA
Continuous (2400 Hz)	81 dBA	74* dBA	28 mA
Continuous (Mechanical)	80 dBA	72* dBA	25 mA
Continuous (Chime)	70* dBA	66* dBA	15 mA
Whoop	82 dBA	69* dBA	56 mA

NOTES:

- For nominal and peak current across ANSI/UL regulated voltage range for filtered DC power and unfiltered (FWR [Full Wave Rectified]) power see installation manual.
- Potter does not recommend using a coded or pulsing signaling circuit with any of our strobe products.
- The sound output for the temporal 3 tone is rated lower since the time the horn is off is averaged into the sound output rating. While the horn is producing a tone in the temporal 3 mode its sound pressure is the same as the continuous mode.
- * Operating the horn in this mode at this voltage will result in not meeting the minimum ANSI/UL 464 reverberant sound level required for public mode fire protection service. These settings are acceptable only for private mode fire alarm use. Use the high dBA setting for public mode application (not applicable when using the chime tone. The chime tone is always private mode).

S-24 & HS-24 Series Wiring Diagram

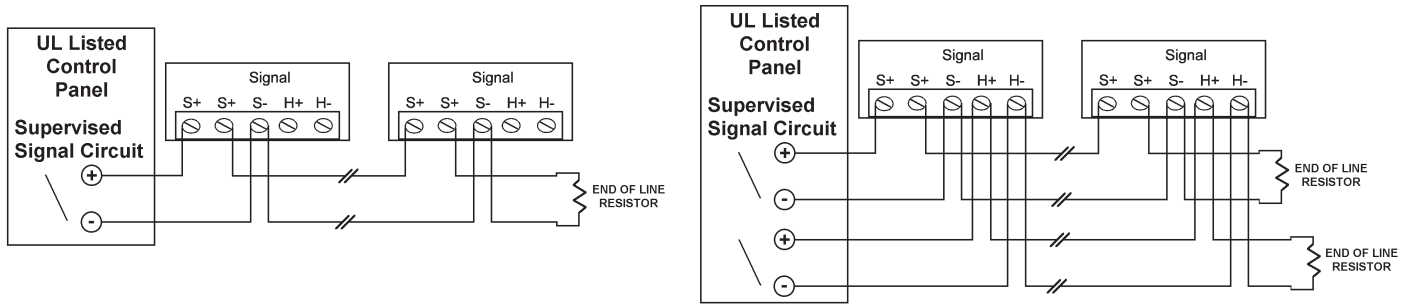

Notes:
All strobes are designed to flash as specified with continuous applied voltage. Strobes should not be used on coded or pulsing signaling circuits. However, use of the Potter AVSM control module or Gentex synchronization protocol is permitted to synchronize the strobe, horn, and/or mute the horn.

• FOR SYNCHRONIZATION WIRING INFORMATION, REFERENCE AVSM CONTROL MODULE DATA SHEET (8830050) AND/OR AVSM CONTROL MODULE MANUAL FOR SYNCHRONIZATION MODULE WIRING DIAGRAMS. AVSM CONTROL MODULE DATA SHEET AND MANUAL CAN BE OBTAINED AT <http://pottersignal.com> OR CALL POTTER ELECTRIC TECHNICAL SUPPORT AT 1-866-956-1211

Architect & Engineering Specifications

The audible and/or visible signal shall be Potter S-24 strobe and Potter HS-24 horn/strobe Series or approved equal and shall be listed by Underwriters Laboratories, Inc. per ANSI/UL 1971 and/or ANSI/UL 464. The notification appliance shall also be listed with Factory Mutual Listing Service (FM) and the California State Fire Marshal (CSFM).

The notification appliance (combination audible/visible) shall produce a peak sound output of 100dBA or greater at 24VDC as measured in an anechoic chamber. The signaling appliance shall also have the capability to silence the audible signal while leaving the visible signal energized with the use of a single pair of power wires. Additionally, the user shall be able to select either continuous or temporal tone output with the temporal signal having the ability to be synchronized.

Unit shall be capable of being installed so that any unauthorized attempt to change the candela setting will result in a trouble signal at the fire alarm control panel.

The audible/visible and visible signaling appliance shall also maintain a minimum flash rate of 1Hz or up to 2Hz regardless of power input voltage. The strobe appliance shall have an operating current of 42mA or less at 24VDC for the 15Cd strobe circuit.

The appliance shall be polarized to allow for electrical supervision of the system wiring. The unit shall be provided with a mounting bracket with terminals and barriers for input/output wiring and be able to mount to a single gang or double gang box or double workbox without the use of an adapter plate. The unit shall have an input voltage range of 16-33 volts with either direct current or full wave rectified power for 24VDC models.

The appliance shall be capable of testing supervision without disconnecting wires, verify voltage without removing unit and be capable of mounting to a surface back box.